

MITSUBISHI ELECTRIC

Air-Conditioners

INDOOR UNIT

CE

PEH-RP8, 10MYA

FOR INSTALLER
FÜR INSTALLATEUR
POUR L'INSTALLATEUR
PARA EL INSTALADOR
PER L'INSTALLATORE
VOOR DE INSTALLATEUR

FÖR INSTALLATÖREN
TIL MONTØREN
PARA O INSTALADOR
ΓΙΑ ΤΟΝ ΤΕΧΝΙΚΟ ΕΓΚΑΤΑΣΤΑΣΗΣ
TESİSATÇININ DİKKATİNE
ДЛЯ СПЕЦИАЛИСТА ПО МОНТАЖУ

INSTALLATION MANUAL

For safe and correct use, please read this installation manual thoroughly before installing the air-conditioner unit.

INSTALLATIONSHANDBUCH

Zum sicheren und ordnungsgemäßen Gebrauch der Klimageräte das Installationshandbuch gründlich durchlesen.

MANUEL D'INSTALLATION

Veuillez lire le manuel d'installation en entier avant d'installer ce climatiseur pour éviter tout accident et vous assurer d'une utilisation correcte.

MANUAL DE INSTALACIÓN

Para un uso seguro y correcto, lea detalladamente este manual de instalación antes de montar la unidad de aire acondicionado.

MANUALE DI INSTALLAZIONE

Per un uso sicuro e corretto, leggere attentamente questo manuale di installazione prima di installare il condizionatore d'aria.

INSTALLATIEHANDLEIDING

Voor een veilig en juist gebruik moet u deze installatiehandleiding grondig doorlezen voordat u de airconditioner installeert.

INSTALLATIONS MANUAL

Läs denna installationsmanual noga för säkert och korrekt bruk innan luftkonditioneringen installeras.

INSTALLATIONS MANUAL

Læs venligst denne installationsmanual grundigt, før De installerer airconditionanlægget, af hensyn til sikker og korrekt anvendelse.

MANUAL DE INSTALAÇÃO

Para segurança e utilização correctas, leia atentamente este manual de instalação antes de instalar a unidade de ar condicionado.

ΕΓΧΕΙΡΙΔΙΟ ΟΔΗΓΙΩΝ ΕΓΚΑΤΑΣΤΑΣΗΣ

Για ασφάλεια και σωστή χρήση, παρακαλείστε διαβάσετε προσεχτικά αυτό το εγχειρίδιο εγκατάστασης πριν αρχίσετε την εγκατάσταση της μονάδας κλιματισμού.

МОНТАЖ ЕЛКІТАБИ

Emniyetli ve doğru biçimde nasıl kullanılacağını öğrenmek için lütfen klima cihazını monte etmeden önce bu elkitabını dikkatle okuyunuz.

РУКОВОДСТВО ПО УСТАНОВКЕ

Для осторожного и правильного использования прибора необходимо тщательно ознакомиться с данным руководством по установке до выполнения установки кондиционера.

GB

D

F

E

I

NL

SW

DK

P

GR

TR

RU

 MITSUBISHI
ELECTRIC

2

[Fig. 2.0.1]

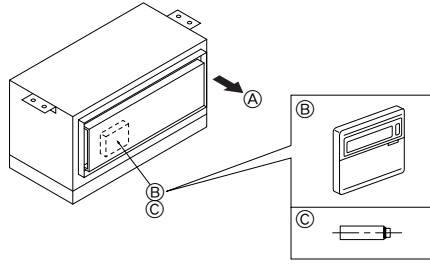

- A Air outlet
 - B Remote controller
 - C Joint pipe for R410A (Field piping connection)
- * In case of PEH-RP8 only

3

3.2

[Fig. 3.2.1]

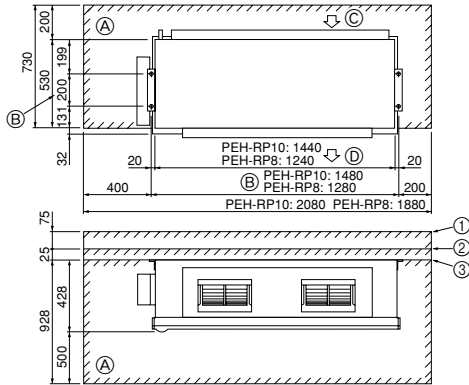

- ① When connecting air inlet
 - ② When installing the suspension fixtures prior to installation of the indoor unit without inlet duct
 - ③ When hanging the indoor unit directly without inlet duct
- A Service space
 - B Suspension bolt pitch
 - C Air inlet
 - D Air outlet

[Fig. 3.2.2]

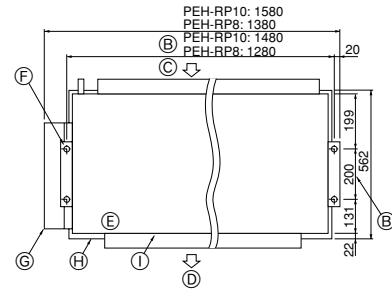

- E Top of the unit
- F 4-φ12 suspension bolt holes
- G Control box
- H Drain pan
- I Main body

4

4.1

[Fig. 4.1.1]

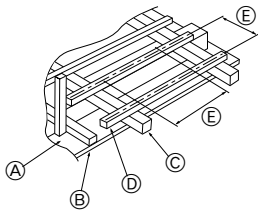

- A Ceiling board
- B Edge beam
- C Tie beam
- D Square timber for hanging the air conditioner
- E Pitch

[Fig. 4.1.2]

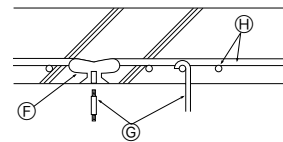

- F Insert: 100 to 150 kg (1 piece) (field supply)
- G M10 hanging bolt (field supply)
- H Reinforcement

5

5.1

[Fig. 5.1.1]

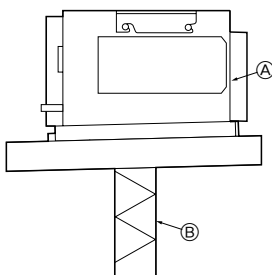

- A Unit body
- B Lifting machine

[Fig. 5.1.2]

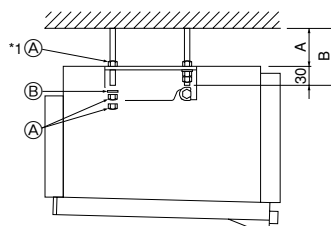

- A Nut
- B Washer

[Fig. 5.1.3]

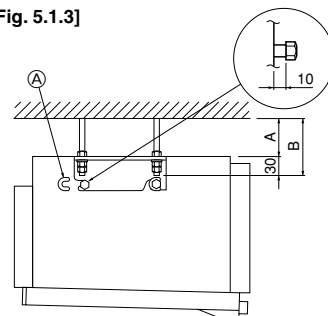

- A Be sure to attach a U-shaped washer (4 washers in total).

5.2

[Fig. 5.2.1]

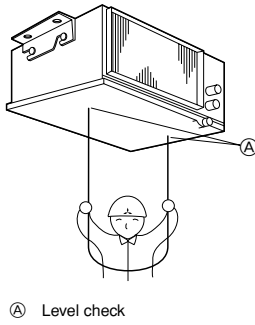

(A) Level check

6

6.2

[Fig. 6.2.1]

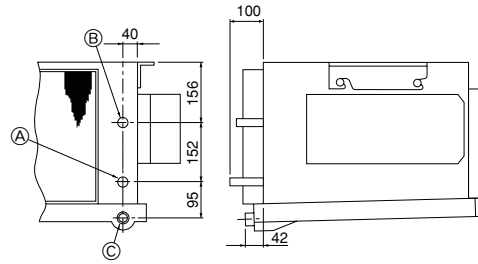

(A) Refrigerant pipe (liquid pipe)
 (B) Refrigerant pipe (gas pipe)
 (C) Drain pipe

7

7.1

[Fig. 7.1.1]

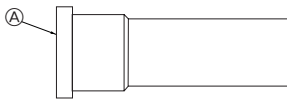

(A) Remove the cap

[Fig.7.1.3]

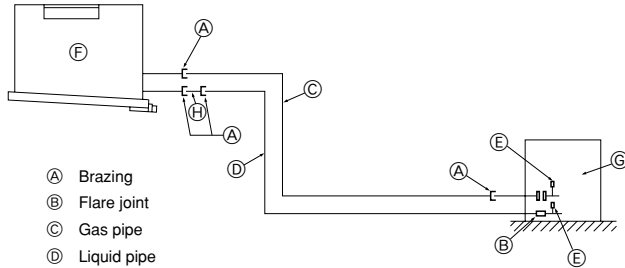

(A) Brazing
 (B) Flare joint
 (C) Gas pipe
 (D) Liquid pipe
 (E) Service port
 (F) Indoor unit
 (G) Outdoor unit
 (H) Joint pipe (Accessory part) * Only for PEH-RP8 when connecting to R410A outdoor unit

[Fig. 7.1.2]

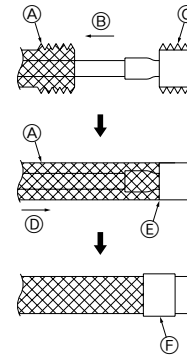

(A) Thermal insulation
 (B) Pull out insulation
 (C) Wrap with damp cloth
 (D) Return to original position
 (E) Ensure that there is no gap here
 (F) Wrap with insulating tape

7.2

[Fig.7.2.1]

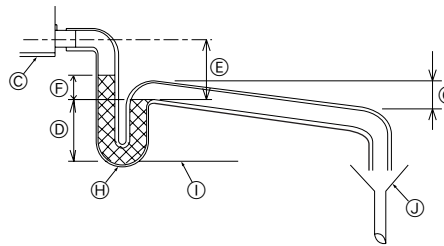
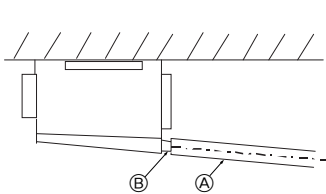

(A) Insulator
 (B) Drain pipe Rc1
 (C) Drain pan
 (D) ≥ 70 mm
 (E) $\geq 2 \times \text{F} \geq 70$ mm
 (F) ≥ 35 mm
 (G) Downward slope 20 mm/m or more
 (H) Drain trap
 (I) The drain pipe should extend below this level.
 (J) Open drain

8

[Fig.8.0.1]

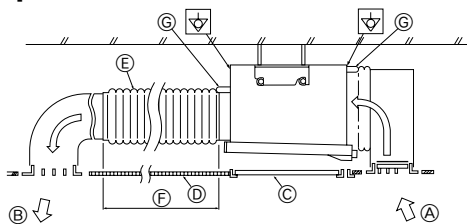

(A) Air inlet
 (B) Air outlet
 (C) Access door
 (D) Ceiling surface
 (E) Canvas duct
 (F) Keep duct-work length 850 or more
 (G) Connect common reference potential wire between duct-work to air conditioner

[Fig.8.0.2]

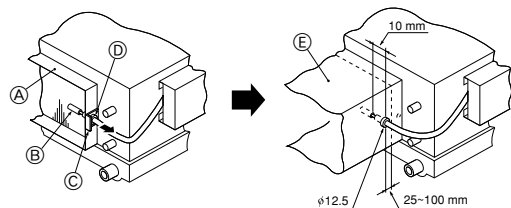

(A) Inlet duct flange
 (B) Inlet temperature sensor
 (C) Sensor protection plate
 (D) Sensor fixture
 (E) Inlet duct

[Fig.8.0.3]

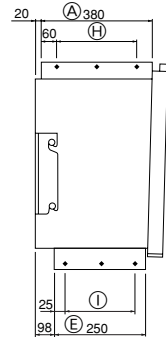
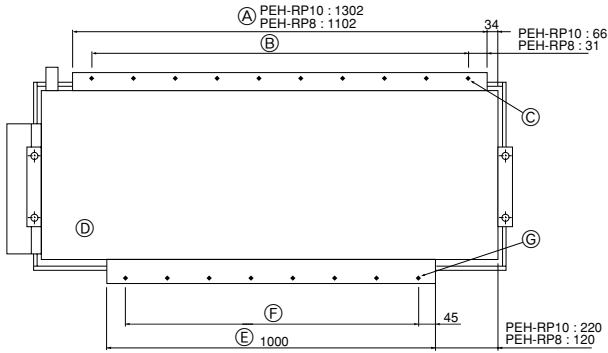

- A Inlet duct flange
- B PEH-RP8: $8 \times 130\text{pitch} = 1040$
PEH-RP10: $9 \times 130\text{pitch} = 1170$
- C PEH-RP8: 24- $\phi 3$ holes (Inlet duct mount holes)
PEH-RP10: 26- $\phi 3$ holes (Inlet duct mount holes)
- D Top of the unit
- E Outlet duct flange
- F PEH-RP8,10: $7 \times 130\text{pitch} = 910$
- G PEH-RP8,10: 22- $\phi 3$ holes (Outlet duct mount holes)
- H PEH-RP8,10: $2 \times 130\text{pitch} = 260$
- I PEH-RP8,10: $2 \times 100\text{pitch} = 200$

9.1

[Fig.9.1.1]

(1)

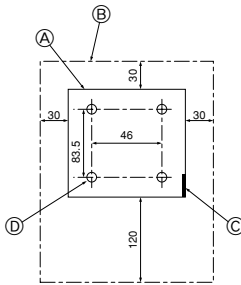

- A Remote controller profile
- B Required clearances surrounding the remote controller
- C Temperature sensor
- D Installation pitch

(2)

<A> For installation in the switch box:

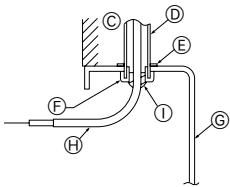

- C Wall
- D Conduit
- E Lock nut
- F Bushing
- G Switch box
- H Remote controller cord
- I Seal with putty.

 For direct installation on the wall select one of the following:

B-1.

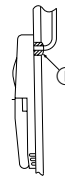

B-2.

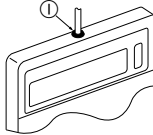

(3)

<A> For installation in the switch box

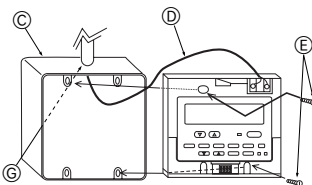

- C Switch box for two pieces
- D Remote controller cord
- E Cross-recessed, pan-head screw
- G Seal the remote controller cord service entrance with putty
- H Wood screw

 For direct installation on the wall

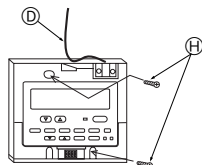

9.2

[Fig.9.2.1]

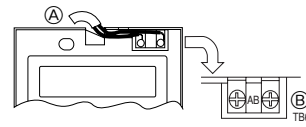

- A To TB5 on the indoor unit
 - B Terminal block representation
- No polarity

[Fig.9.2.2]

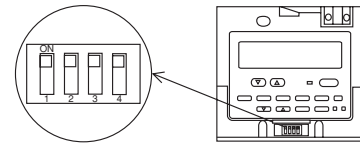

9.3

[Fig.9.3.1]

(1)

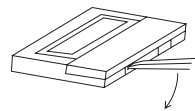

(2)

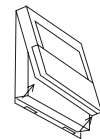

9.4

[Fig.9.4.1]

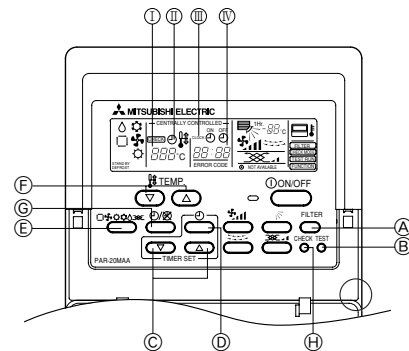

- I Mode number
- II Setting number
- III Refrigerant address
- IV Unit number

[Fig.9.4.2]

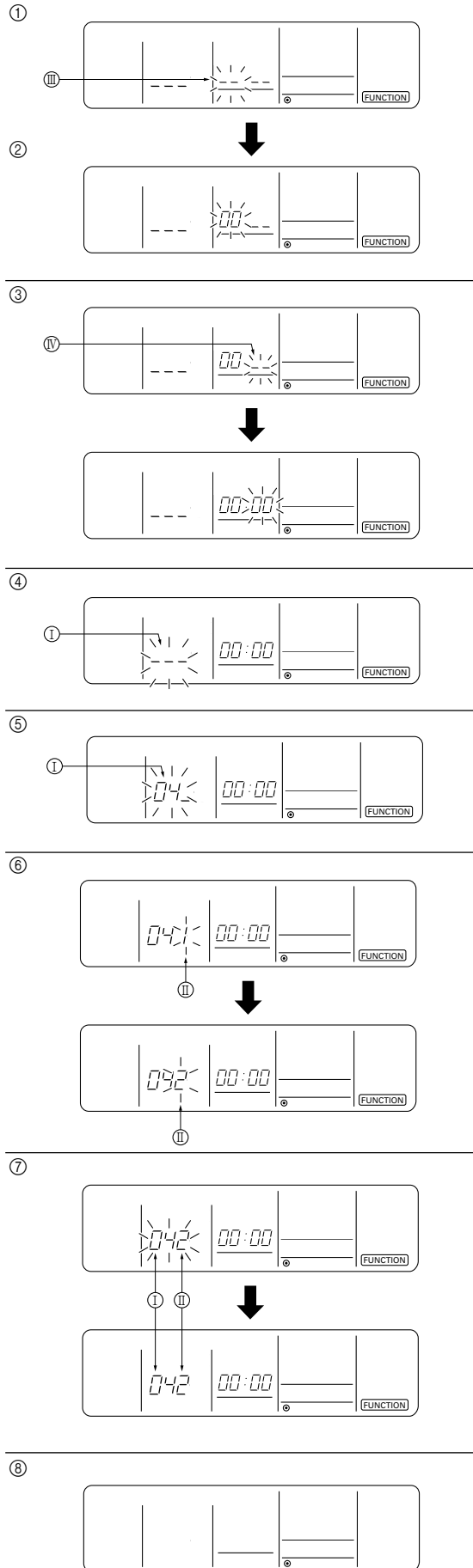

[Fig.9.4.3]

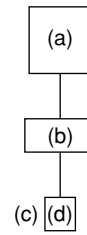

- (a) Outdoor unit
- (b) Indoor unit
- (c) Designate operation
- (d) Remote controller

[Fig.9.4.4]

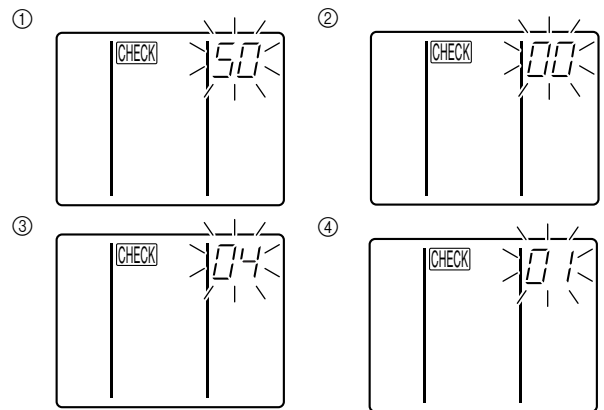
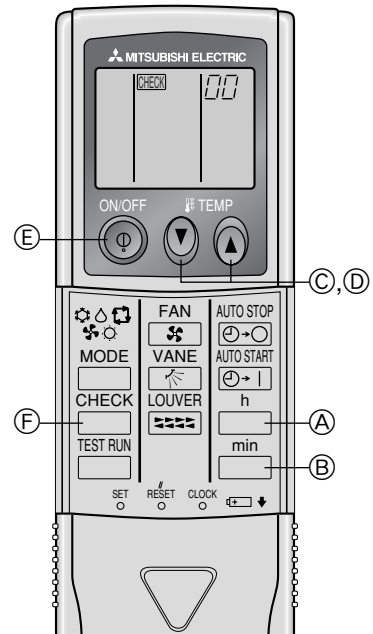

[Fig.10.0.1]

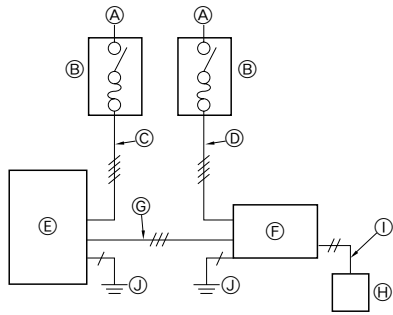

- Ⓐ Power supply
- Ⓑ Main switch/fuse (purchased locally)
- Ⓒ Power supply wiring for outdoor unit
- Ⓓ Power supply wiring for indoor unit
- Ⓔ Outdoor unit
- Ⓕ Connection wiring for indoor/outdoor units (polarity)
- Ⓖ Indoor unit
- Ⓗ Remote controller
- Ⓙ Connection wiring for indoor/remote controller (no polarity)
- ⓫ Grounding
- ⓬ Signal wiring for alternate defrost

[Fig.10.0.2]

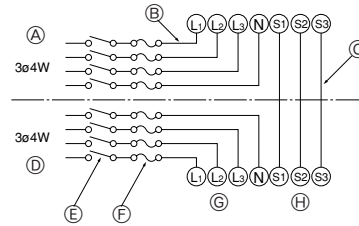

- Ⓐ Indoor unit
- Ⓑ Power cable wiring
- Ⓒ Control cable wiring
- Ⓓ Outdoor unit
- Ⓔ Breaker
- Ⓕ Power cable terminal bed
- Ⓖ Defrost signal cable terminal bed
- Ⓗ Defrost signal cable wiring

[Fig.10.0.3]

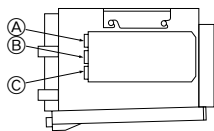

- Ⓐ For remote controller cables
- Ⓑ For outdoor unit connection cables
- Ⓒ For power supply cables

[Fig.10.0.4]

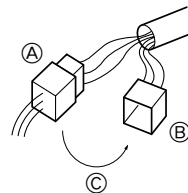

- Ⓐ White connector (50 Pa) C01
- Ⓑ Red connector (150 Pa) C02
- Ⓒ Remove

[Fig.11.2.1]

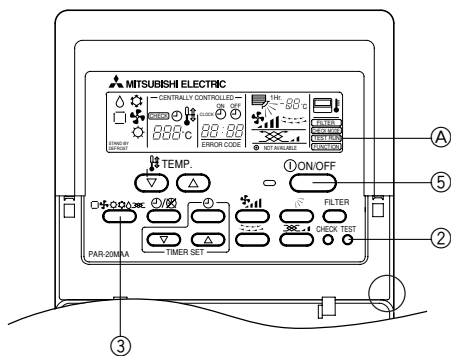

[Fig.11.2.2]

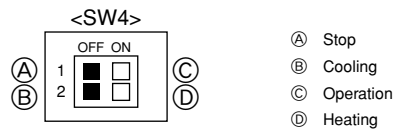

- Ⓐ Stop
- Ⓑ Cooling
- Ⓒ Operation
- Ⓓ Heating

11.3

[Fig.11.3.1]

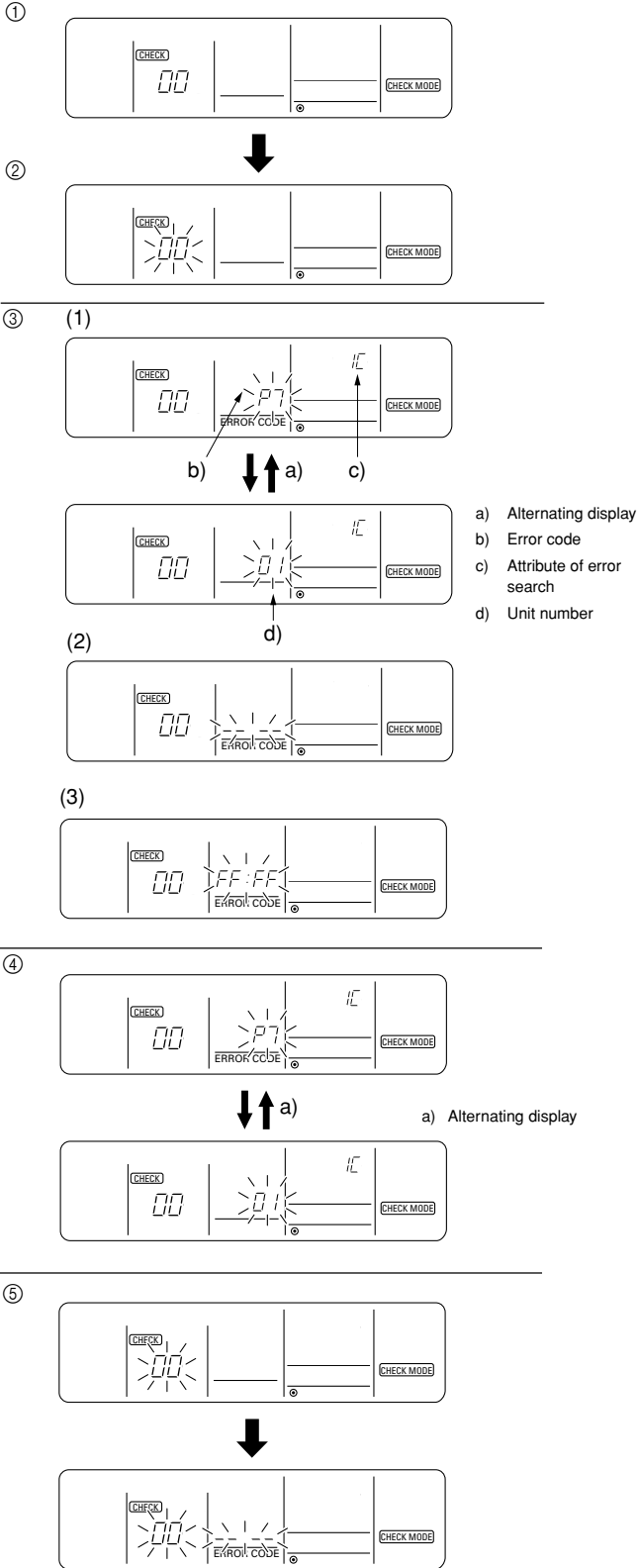

11.4

[Fig.11.4.1]

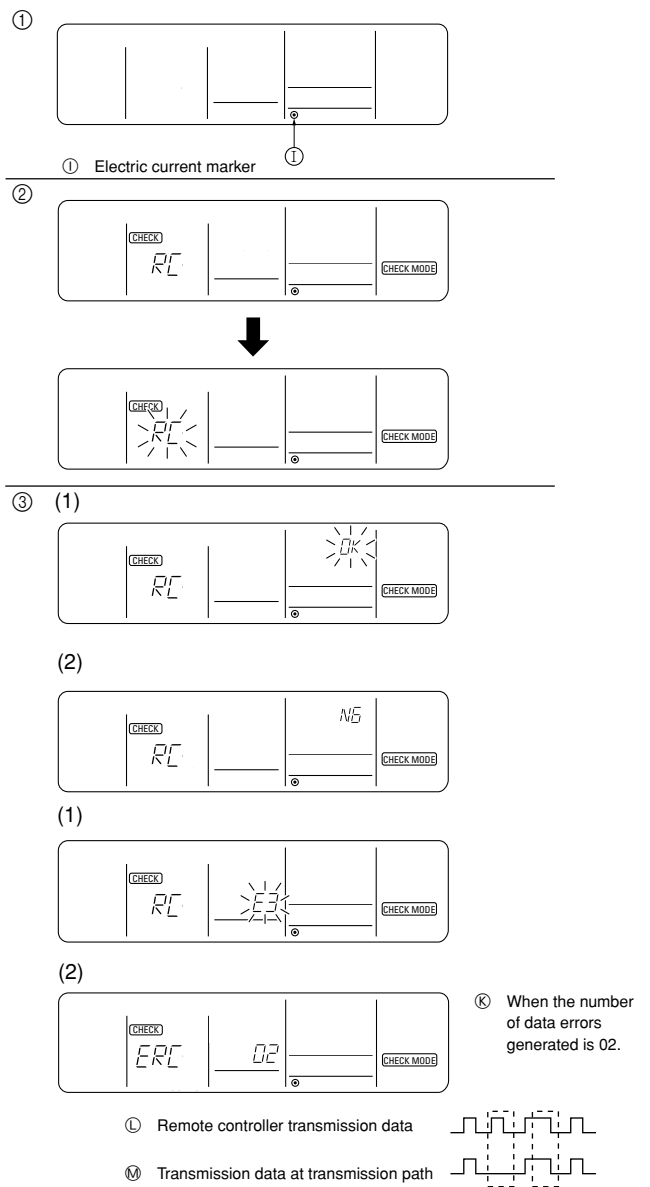

12 **12.2**

[Fig.12.2.1]

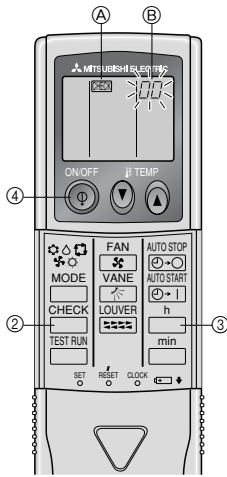

12.3

[Fig.12.3.1]

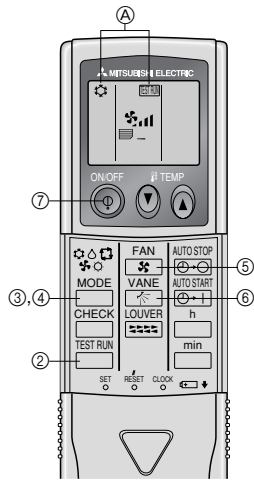

14 **14.1**

[Fig.14.1.1]

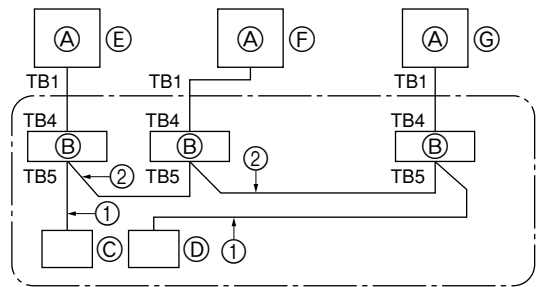

- Ⓐ Outdoor unit
 - Ⓑ Indoor unit
 - Ⓒ Master remote controller
 - Ⓓ Subordinate remote controller
 - Ⓔ Standard 1:1 (Refrigerant address = 00)
- Ⓔ SW 1 - 3 ~ 6
- | | | | | |
|-----|---|---|---|---|
| ON | | | | |
| OFF | | | | |
| | 3 | 4 | 5 | 6 |

Contents

1. Safety precautions	9	8. Duct work	13
1.1. Before installation and electric work	9	9. Remote controller	13
1.2. Precautions for devices that use R410A refrigerant	10	9.1. Installing procedures	13
1.3. Before getting installed	10	9.2. Connecting procedures	14
1.4. Before getting installed (moved) - electrical work	10	9.3. Fitting the upper case	14
1.5. Before starting the test run	10	9.4. Function settings	14
2. Indoor unit accessories	10	10. Electrical wiring	16
3. Selecting an installation site	11	11. Test run	17
3.1. Install the indoor unit on a ceiling strong enough to sustain its weight	11	11.1. Before test run	17
3.2. Securing installation and service space	11	11.2. Test run procedures	17
3.3. Combining indoor units with outdoor units	11	11.3. Self-diagnosis	18
4. Fixing hanging bolts	11	11.4. Remote controller diagnosis	18
4.1. Fixing hanging bolts	11	12. Test run [for wireless remote controller]	19
5. Installing the unit	11	12.1. Before test run	19
5.1. Hanging the unit body	11	12.2. Self-check	19
5.2. Confirming the unit's position and fixing hanging bolts	12	12.3. Test run method	20
6. Refrigerant pipe and drain pipe specifications	12	13. Troubleshooting	20
6.1. Refrigerant pipe and drain pipe specifications	12	13.1. How to handle problems with the test run	20
6.2. Refrigerant pipe, drain pipe and filling port	12	13.2. The following occurrences are not problems or errors	21
7. Connecting refrigerant pipes and drain pipes	12	14. System control	21
7.1. Refrigerant piping work	12	14.1. System settings	21
7.2. Drain piping work	13	14.2. Examples of refrigerant system address setting	21

1. Safety precautions

1.1. Before installation and electric work

- ▶ Before installing the unit, make sure you read all the “Safety precautions”.
- ▶ The “Safety precautions” provide very important points regarding safety. Make sure you follow them.

Symbols used in the text





Warning:

Describes precautions that should be observed to prevent danger of injury or death to the user.

Caution:

Describes precautions that should be observed to prevent damage to the unit.

Symbols used in the illustrations

-  : Indicates an action that must be avoided.
-  : Indicates that important instructions must be followed.
-  : Indicates a part which must be grounded.
-  : Indicates that caution should be taken with rotating parts. (This symbol is displayed on the main unit label.) <Color: yellow>
-  : Beware of electric shock. (This symbol is displayed on the main unit label.) <Color: yellow>

Warning:

Carefully read the labels affixed to the main unit.

Warning:

- Ask the dealer or an authorized technician to install the air conditioner.
 - Improper installation by the user may result in water leakage, electric shock, or fire.
- For installation work, follow the instructions in the installation Manual and use tools and pipe components specifically made for use with R410A refrigerant. The R410A refrigerant in the HFC system is pressurized 1.6 times the pressure of usual refrigerants. If pipe components not designed for R410A refrigerant are used and the unit is not installed correctly, the pipe may burst and cause damage or injuries. In addition, water leakage, electric shock, or fire may result.
- Install the unit at a place that can withstand its weight.
 - Inadequate strength may cause the unit to fall down, resulting in injuries.
- Use the specified cables for wiring. Make the connections securely so that the outside force of the cable is not applied to the terminals.
 - Inadequate connection and fastening may generate heat and cause a fire.
- Prepare for strong winds and earthquakes and install the unit at the specified place.
 - Improper installation may cause the unit to topple and result in injury.
- Always use an filter and other accessories specified by Mitsubishi Electric.
 - Ask an authorized technician to install the accessories. Improper installation by the user may result in water leakage, electric shock, or fire.
- Never repair the unit. If the air conditioner must be repaired, consult the dealer.
 - If the unit is repaired improperly, water leakage, electric shock, or fire may result.
- Do not touch the heat exchanger fins.
 - Improper handling may result in injury.
- When handling this product, always wear protective equipment. EG: Gloves, full arm protection namely boiler suit, and safety glasses.
 - Improper handling may result in injury.
- If refrigerant gas leaks during installation work, ventilate the room.
 - If the refrigerant gas comes into contact with a flame, poisonous gases will be released.
- Install the air conditioner according to this Installation Manual.
 - If the unit is installed improperly, water leakage, electric shock, or fire may result.
- Have all electric work done by a licensed electrician according to “Electric Facility Engineering Standard” and “Interior Wire Regulations” and the instructions given in this manual and always use a special circuit.
 - If the power source capacity is inadequate or electric work is performed improperly, electric shock and fire may result.
- Securely install the outdoor unit terminal cover (panel).
 - If the terminal cover (panel) is not installed properly, dust or water may enter the outdoor unit and fire or electric shock may result.
- When installing and moving the air conditioner to another site, do not charge the it with a refrigerant different from the refrigerant (R410A) specified on the unit.
 - If a different refrigerant or air is mixed with the original refrigerant, the refrigerant cycle may malfunction and the unit may be damaged.
- If the air conditioner is installed in a small room, measures must be taken to prevent the refrigerant concentration from exceeding the safety limit even if the refrigerant should leak.
 - Consult the dealer regarding the appropriate measures to prevent the safety limit from being exceeded. Should the refrigerant leak and cause the safety limit to be exceeded, hazards due to lack of oxygen in the room could result.
- When moving and reinstalling the air conditioner, consult the dealer or an authorized technician.
 - If the air conditioner is installed improperly, water leakage, electric shock, or fire may result.
- After completing installation work, make sure that refrigerant gas is not leaking.
 - If the refrigerant gas leaks and is exposed to a fan heater, stove, oven, or other heat source, it may generate noxious gases.
- Do not reconstruct or change the settings of the protection devices.
 - If the pressure switch, thermal switch, or other protection device is shorted and operated forcibly, or parts other than those specified by Mitsubishi Electric are used, fire or explosion may result.
- To dispose of this product, consult your dealer.
- The installer and system specialist shall secure safety against leakage according to local regulation or standards.
 - Following standards may be applicable if local regulation are not available.
- Pay a special attention to the place, such as a basement, etc. where refrigeration gas can stay, since refrigeration is heavier than the air.

1.2. Precautions for devices that use R410A refrigerant

⚠ Caution:

- **Use refrigerant piping made of phosphorus deoxidized copper.** In addition, be sure that the inner and outer surfaces of the pipes are clean and free of hazardous sulphur, oxides, dust/dirt, shaving particles, oils, moisture, or any other contaminant. Use pipes with the specified thickness. (Refer to the 7.1.) Note the following if reusing existing pipes that carried R22 refrigerant.
 - Replace the existing flare nuts and flare the flared sections again.
 - Do not use thin pipes. (Refer to the 7.1.)
 - Contaminants on the inside of the refrigerant piping may cause the refrigerant residual oil to deteriorate.
- **Store the piping to be used during installation indoors and keep both ends of the piping sealed until just before brazing. (Store elbows and other joints in a plastic bag.)**
 - If dust, dirt, or water enters the refrigerant cycle, deterioration of the oil and compressor trouble may result.
- **Use ester oil, ether oil or alkylbenzene (small amount) as the refrigerator oil to coat flares and flange connections.**
 - The refrigerator oil will degrade if it is mixed with a large amount of mineral oil.
- **Use liquid refrigerant to fill the system.**
 - If gas refrigerant is used to seal the system, the composition of the refrigerant in the cylinder will change and performance may drop.
- **Do not use a refrigerant other than R410A.**
 - If another refrigerant (R22, etc.) is used, the chlorine in the refrigerant may cause the refrigerator oil to deteriorate.
- **Use a vacuum pump with a reverse flow check valve.**
 - The vacuum pump oil may flow back into the refrigerant cycle and cause the refrigerator oil to deteriorate.
- **Use the following tools specifically designed for use with R410A refrigerant.**

The following tools are necessary to use R410A refrigerant. Contact your nearest dealer for any questions.

Tools (for R410A)	
Gauge manifold	Flare tool
Charge hose	Size adjustment gauge
Gas leak detector	Vacuum pump adapter
Torque wrench	Electronic refrigerant charging scale

- **Do not use a charging cylinder.**
 - Using a charging cylinder may cause the refrigerant to deteriorate.
- **Be especially careful when managing the tools.**
 - If dust, dirt, or water gets in the refrigerant cycle, the refrigerant may deteriorate.

1.3. Before getting installed

⚠ Caution:

- **Do not install the unit where combustible gas may leak.**
 - If the gas leaks and accumulates around the unit, an explosion may result.
- **Do not use the air conditioner where food, pets, plants, precision instruments, or artwork are kept.**
 - The quality of the food, etc. may deteriorate.
- **Do not use the air conditioner in special environments.**
 - Oil, steam, sulfuric smoke, etc. can significantly reduce the performance of the air conditioner or damage its parts.
- **When installing the unit in a hospital, communication station, or similar place, provide sufficient protection against noise.**
 - The inverter equipment, private power generator, high-frequency medical equipment, or radio communication equipment may cause the air conditioner to operate erroneously, or fail to operate. On the other hand, the air conditioner may affect such equipment by creating noise that disturbs medical treatment or image broadcasting.

- **Do not install the unit on a structure that may cause leakage.**
 - When the room humidity exceeds 80 % or when the drain pipe is clogged, condensation may drip from the indoor unit. Perform collective drainage work together with the outdoor unit, as required.

1.4. Before getting installed (moved) - electrical work

⚠ Caution:

- **Ground the unit.**
 - Do not connect the ground wire to gas or water pipes, lightning rods, or telephone ground lines. Improper grounding may result in electric shock.
- **Install the power cable so that tension is not applied to the cable.**
 - Tension may cause the cable to break and generate heat and cause a fire.
- **Install an leak circuit breaker, as required.**
 - If an leak circuit breaker is not installed, electric shock may result.
- **Use power line cables of sufficient current carrying capacity and rating.**
 - Cables that are too small may leak, generate heat, and cause a fire.
- **Use only a circuit breaker and fuse of the specified capacity.**
 - A fuse or circuit breaker of a larger capacity or a steel or copper wire may result in a general unit failure or fire.
- **Do not wash the air conditioner units.**
 - Washing them may cause an electric shock.
- **Be careful that the installation base is not damaged by long use.**
 - If the damage is left uncorrected, the unit may fall and cause personal injury or property damage.
- **Install the drain piping according to this Installation Manual to ensure proper drainage. Wrap thermal insulation around the pipes to prevent condensation.**
 - Improper drain piping may cause water leakage and damage to furniture and other possessions.
- **Be very careful about product transportation.**
 - Only one person should not carry the product if it weighs more than 20 kg.
 - Some products use PP bands for packaging. Do not use any PP bands for a means of transportation. It is dangerous.
 - Do not touch the heat exchanger fins. Doing so may cut your fingers.
 - When transporting the outdoor unit, suspend it at the specified positions on the unit base. Also support the outdoor unit at four points so that it cannot slip sideways.
- **Safely dispose of the packing materials.**
 - Packing materials, such as nails and other metal or wooden parts, may cause stabs or other injuries.
 - Tear apart and throw away plastic packaging bags so that children will not play with them. If children play with a plastic bag which was not torn apart, they face the risk of suffocation.

1.5. Before starting the test run

⚠ Caution:

- **Turn on the power at least 12 hours before starting operation.**
 - Starting operation immediately after turning on the main power switch can result in severe damage to internal parts. Keep the power switch turned on during the operational season.
- **Do not touch the switches with wet fingers.**
 - Touching a switch with wet fingers can cause electric shock.
- **Do not touch the refrigerant pipes during and immediately after operation.**
 - During and immediately after operation, the refrigerant pipes are may be hot and may be cold, depending on the condition of the refrigerant flowing through the refrigerant piping, compressor, and other refrigerant cycle parts. Your hands may suffer burns or frostbite if you touch the refrigerant pipes.
- **Do not operate the air conditioner with the panels and guards removed.**
 - Rotating, hot, or high-voltage parts can cause injuries.
- **Do not turn off the power immediately after stopping operation.**
 - Always wait at least five minutes before turning off the power. Otherwise, water leakage and trouble may occur.

2. Indoor unit accessories

The unit is provided with the following accessories:

[Fig. 2.0.1] (P.2)

<Accessory part position>

- Ⓐ Air outlet
- Ⓑ Remote controller
- Ⓒ Joint pipe for R410A (Field piping connection)

* In case of PEH-RP8 only

3. Selecting an installation site

- Select a site with sturdy fixed surface sufficiently durable against the weight of unit.
- Before installing unit, the routing to carry in unit to the installation site should be determined.
- Select a site where the unit is not affected by entering air.
- Select a site where the flow of supply and return air is not blocked.
- Select a site where refrigerant piping can easily be led to the outside.
- Select a site which allows the supply air to be distributed fully in room.
- Do not install unit at a site with oil splashing or steam in much quantity.
- Do not install unit at a site where combustible gas may generate, flow in, stagnate or leak.
- Do not install unit at a site where equipment generating high frequency waves (a high frequency wave welder for example) is provided.
- Do not install unit at a site where fire detector is located at the supply air side. (Fire detector may operate erroneously due to the heated air supplied during heating operation.)
- When special chemical product may scatter around such as site chemical plants and hospitals, full investigation is required before installing unit. (The plastic components may be damaged depending on the chemical product applied.)

3.1. Install the indoor unit on a ceiling strong enough to sustain its weight

⚠ Warning:

The unit must be securely installed on a structure that can sustain its weight. If the unit is mounted on an unstable structure, it may fall down causing injuries.

4. Fixing hanging bolts

4.1. Fixing hanging bolts

(Use M10 hanging bolts. The bolts should be supplied in the field.)
(Give site of suspension strong structure.)

Hanging structure

- Ceiling: The ceiling structure varies from building to one another. For detailed information, consult your construction company.
- ① Reinforcing the ceiling with additional members (edge beam, etc) must be required to keep the ceiling at level and to prevent the ceiling from vibrations.
 - ② Cut and remove the ceiling members.
 - ③ Reinforce the ceiling members, and add other members for fixing the ceiling boards.

For wooden construction

- Use the tie beam (for one story building) or second-floor beam (for two story building) as strength members.

5. Installing the unit

5.1. Hanging the unit body

- ▶ Bring the indoor unit to an installation site as it is packed.
- ▶ To hang the indoor unit, use a lifting machine to lift and pass through the hanging bolts.
- ▶ Install the indoor unit before ceiling work.

[Fig. 5.1.1] (P.2)

- Ⓐ Unit body
- Ⓑ Lifting machine

* Two installation methods are available
<When hanging the indoor unit directly>

1. Attach a washer and nut(s) to each suspension bolt. (The washers and nuts are to be supplied locally.)
2. Fit the indoor unit to each suspension bolt.
3. Make sure that the unit is positioned level, then tighten each nut.

[Fig. 5.1.2] (P.2)

- Ⓐ Nut
- Ⓑ Washer

	A	B
When using inlet duct	100 or more	130 or more
When not using inlet duct	0 or more	30 or more

Nut (*1) is not required if distance A is 0.

3.2. Securing installation and service space

- Select the optimum direction of supply airflow according to the configuration of the room and the installation position.
- As the piping and wiring are connected at the bottom and side surfaces, and the maintenance is made at the same surfaces, allow a proper space properly. For the efficient suspension work and safety, provide a space as much as possible.

Service space

[Fig. 3.2.1] (P.2)

- ① When connecting air inlet
- ② When installing the suspension fixtures prior to installation of the indoor unit without inlet duct
- ③ When hanging the indoor unit directly without inlet duct
- Ⓐ Service space
- Ⓑ Suspension bolt pitch
- Ⓒ Air inlet
- Ⓓ Air outlet

Suspension bolt pitch

[Fig. 3.2.2] (P.2)

- Ⓔ Top of the unit
- Ⓕ Control box
- Ⓗ 4-φ12 suspension bolt
- Ⓖ Drain pan
- Ⓘ Main body

3.3. Combining indoor units with outdoor units

For combining indoor units with outdoor units, refer to the outdoor unit installation manual.

- To hang the air-conditioner, use a hard square timber of more than 6 cm if the distance between beams is less than 90 cm and a hard square timber of more than 9 cm if the distance between beams is less than 180 cm.

[Fig. 4.1.1] (P.2)

- Ⓐ Ceiling board
- Ⓑ Edge beam
- Ⓒ Tie beam
- Ⓓ Square timber for hanging the air conditioner
- Ⓔ Pitch

For reinforced concrete construction

- As shown in the figure below, fix the hanging bolts, or use square timbers to fix the hanging bolts.

[Fig. 4.1.2] (P.2)

- Ⓕ Insert: 100 to 150 kg (1 piece) (field supply)
- Ⓖ M10 hanging bolt (field supply)
- Ⓖ Reinforcement

Product Weight (kg)

PEH-RP8MYA	70 kg
PEH-RP10MYA	80 kg

<When installing the suspension fixture prior to installation of the indoor unit>

1. Loosen each suspension fixture bolt slightly, and remove the fixture and U-shaped washers.
2. Adjust each suspension fixture bolt.
3. Attach a washer, nut and suspension fixture to each suspension bolt. (The washers and nuts are to be supplied locally.)
4. Hook the indoor unit to the suspension fixtures.
5. Make sure that the unit is positioned level, then tighten each nut.

[Fig. 5.1.3] (P.2)

- Ⓐ Be sure to attach a U-shaped washer (4 washers in total).

	A	B
When using inlet duct	100 or more	130 or more
When not using inlet duct	25 or more	55 or more

5.2. Confirming the unit's position and fixing hanging bolts

[Fig. 5.2.1] (P.3)

Ⓐ Level check

- ▶ Use the gage supplied with the panel to confirm that the unit body and hanging bolts are positioned in place. If they are not positioned in place, it may result in dew drops due to wind leak. Be sure to check the positional relationship.

- ▶ Use a level to check that the surface indicated by Ⓐ is at level. Ensure that the hanging bolt nuts are tightened to fix the hanging bolts.
- ▶ To ensure that drain is discharged, be sure to hang the unit at level using a level.



Caution:

Be sure to install the unit body at level.

6. Refrigerant pipe and drain pipe specifications

To avoid dew drops, provide sufficient antisweating and insulating work to the refrigerant and drain pipes.

When using commercially available refrigerant pipes, be sure to wind commercially available insulating material (with a heat-resisting temperature of more than 100 °C and thickness given below) onto both liquid and gas pipes.

Be also sure to wind commercially available insulating material (with a form polyethylene's specific gravity of 0.03 and thickness given below) onto all pipes which pass through rooms.

- ① Select the thickness of insulating material by pipe size.

Pipe size	Insulating material's thickness
6.4 mm to 25.4 mm	More than 10 mm
28.6 mm to 38.1 mm	More than 15 mm

- ② If the unit is used on the highest story of a building and under conditions of high temperature and humidity, it is necessary to use pipe size and insulating material's thickness more than those given in the table above.

- ③ If there are customer's specifications, simply follow them.

6.1. Refrigerant pipe and drain pipe specifications

Item	Model	PEH-RP8MYA	PEH-RP10MYA
	Refrigerant pipe	Liquid pipe	ø9.52
Gas pipe		ø25.4	ø28.58
Drain pipe		RC1 (Male screw)	

6.2. Refrigerant pipe, drain pipe and filling port

[Fig. 6.2.1] (P.3)

Ⓐ Refrigerant pipe (liquid pipe)

Ⓑ Refrigerant pipe (gas pipe)

Ⓒ Drain pipe

7. Connecting refrigerant pipes and drain pipes

7.1. Refrigerant piping work

This piping work must be done in accordance with the installation manuals for outdoor unit.

- For constraints on pipe length and allowable difference of elevation, refer to the outdoor unit manual.
- The method of pipe connection is brazing connection.

Cautions on refrigerant piping

- ▶ Be sure to use non-oxidative brazing for brazing to ensure that no foreign matter or moisture enter into the pipe.
- ▶ Provide a metal brace to support the refrigerant pipe so that no load is imparted to the indoor unit end pipe. This metal brace should be provided 50 cm away from the indoor unit's brazing connection.

⚠ Warning:

Do not mix anything other than the specified refrigerant (R410A) into the refrigerating cycle. Mixing air may cause the refrigerating cycle to get abnormally high temperature, resulting in a burst.

⚠ Caution:

- Install the refrigerant piping for the indoor unit in accordance with the following.

1. Remove the cap.

[Fig. 7.1.1] (P.3)

Ⓐ Remove the cap

2. Pull out the thermal insulation on the site refrigerant piping, braze the unit piping, and replace the insulation in its original position. Wrap the piping with insulating tape.

[Fig. 7.1.2] (P.3)

Ⓐ Thermal insulation

Ⓑ Pull out insulation

Ⓒ Wrap with damp cloth

Ⓓ Return to original position

Ⓔ Ensure that there is no gap here

Ⓕ Wrap with insulating tape

Note:

- Pay strict attention when wrapping the copper piping since wrapping the piping may cause condensation instead of preventing it.

* Before brazing the refrigerant piping, always wrap the piping on the main body, and the thermal insulation piping, with damp cloths to prevent heat shrinkage and burning the thermal insulation tubing. Take care to ensure that the flame does not come into contact with the main body itself.

⚠ Caution:

- Refer to the 1.2. for precautions not included below on using air conditioners with R410A refrigerant.

- Use C1220 copper phosphorus, for copper and copper alloy seamless pipes, to connect the refrigerant pipes. Use refrigerant pipes with the thicknesses specified in the table to the below. Make sure the insides of the pipes are clean and do not contain any harmful contaminants such as sulfuric compounds, oxidants, debris, or dust.

Pipe size (mm)	ø9.52	ø12.7	ø25.4	ø28.58
Thickness (mm)	0.8	0.8	1.0	1.0

- Do not use pipes thinner than those specified above.
- Store the piping to be used during installation indoors and keep both ends of the piping sealed until just before brazing.
 - If dust, dirt, or water gets into the refrigerant cycle, the oil will deteriorate and the compressor may fail.
- Use ester oil, ether oil or alkylbenzene (small amount) as the refrigerant oil to coat flares and flange connections.
 - The refrigerant used in the unit is highly hygroscopic and mixes with water and will degrade the refrigerant oil.
- Do not use a leak detection additive.

Additional refrigerant charge

- Take care not to allow dirt or cutting chips to enter the refrigerant pipes.
- The refrigerant pipes must be kept warm, so take particular care to insulate between refrigerant pipes and the gas pipe located inside the indoor unit, since the gas pipe causes condensation during cooling operation.
- When connecting the refrigerant pipes, make sure that the stop valve of the outdoor unit is fully closed (as it was when shipped from the factory). After connecting all the refrigerant pipes between the indoor and outdoor units, purge air from the stop valve service port of the outdoor unit and service port of each connecting pipe. Check that there is no air leakage from any pipe connection, then fully open the stop valve of the outdoor unit. This will connect the refrigerant circuit between the indoor and outdoor units.
- The refrigerant pipes must be as short as possible.
- Flare and flange connections must be used for connection of the refrigerant pipes.
- The indoor and outdoor units must be connected with the refrigerant pipes.

[Fig. 7.1.3] (P.3)

Ⓐ Brazing

Ⓑ Flare joint

Ⓒ Gas pipe

Ⓓ Liquid pipe

Ⓔ Service port

Ⓕ Indoor unit

Ⓖ Outdoor unit

Ⓗ Joint pipe (Accessory part)

* Only for PEH-RP8 when connecting to R410A outdoor unit

⚠ Warning:

When installing or moving the air conditioner, use only the specified refrigerant (R410A) to charge the refrigerant lines. Do not mix it with any other refrigerant and do not allow air to remain in the lines. Air enclosed in the lines can cause pressure peaks resulting in a rupture and other hazards.

Indoor unit		PEH-RP8	PEH-RP10
Refrigerant		R407C	
Joint outdoor unit		PUH-P8	PUH-P10
Refrigerant	Liquid side	ø12.7	ø12.7
Pipe size (mm)	Gas side	ø25.4	ø28.58

Indoor unit		PEH-RP8	PEH-RP10
Refrigerant		R410A	
Joint outdoor unit		PUHZ-RP8	PUHZ-RP10
Refrigerant	Liquid side	ø9.52*	ø12.7
Pipe size (mm)	Gas side	ø25.4	ø28.58

* When connecting to R410A outdoor unit, use the joint pipe which is attached to the indoor unit.

▶ Refer to the installation manual for details of the additional amount of refrigerant for the outdoor unit.

8. Duct work

- In connecting duct, insert canvas duct between unit and duct.
- Use incombustible material for duct parts.
- Provide full insulation to inlet duct flange, outlet duct flange and outlet duct to prevent condensation.
- Be sure to apply the air filter near the air inlet grille.
- Before connecting an inlet duct, remove the air filter (supplied with the unit), then install that filter in the inlet grille.

[Fig. 8.0.1] (P.3)

- Ⓐ Air inlet
- Ⓑ Air outlet
- Ⓒ Access door
- Ⓓ Ceiling surface
- Ⓔ Canvas duct
- Ⓕ Keep duct-work length 850 or more
- Ⓖ Connect common reference potential wire between duct-work to air conditioner

⚠ Caution:

- Outlet duct is 850 mm or more necessary to construct.
- To connect the air conditioner main body and the duct for potential equalization.

- Inlet temperature sensor when an inlet duct is installed.
An inlet temperature sensor is installed on the inlet duct flange. Before connecting an inlet duct, this sensor must be removed and installed in the specified position.

[Fig. 8.0.2] (P.3)

- Ⓐ Inlet duct flange
- Ⓑ Inlet temperature sensor
- Ⓒ Sensor protection plate
- Ⓓ Sensor fixture
- Ⓔ Inlet duct

- ① Pull out the sensor, and remove the sensor fixture and protection plate. (The protection plate must be discarded.)

9. Remote controller

9.1. Installing procedures

- (1) Select an installing position for the remote controller (switch box).
Be sure to observe the following precautions.

[Fig. 9.1.1] (P.4)

- Ⓐ Remote controller profile
- Ⓑ Required clearances surrounding the remote controller
- Ⓒ Temperature sensor
- Ⓓ Installation pitch

- ① The temperature sensors are located on both remote controller and indoor unit. To use the temperature sensor on the remote controller, mainly use the remote controller for temperature setting or room temperature detection. Install the remote controller in such an area that can detect average room temperatures, free of direct sunlight, airflow from the air conditioner, and other such heating source.
- ② In either case when the remote controller is installed in the switch box or on the wall, provide the clearances indicated in the diagram. (When the schedule timer is used in combination, also refer to the installation manual supplied with the schedule timer.)

Note:

Check that there is no electric wire left close to the remote controller sensor. If any electric wire is near the sensor, the remote controller may fail to detect a correct room temperature.

7.2. Drain piping work

[Fig. 7.2.1] (P.3)

- Ⓐ Insulator
- Ⓑ Drain pipe Rc1
- Ⓒ Drain pan
- Ⓓ ≥ 70 mm
- Ⓔ ≥ 2 × Ⓕ ≥ 70 mm
- Ⓖ ≥ 35 mm
- Ⓖ Downward slope 20 mm/m or more
- Ⓗ Drain trap
- ① The drain pipe should extend below this level.
- ② Open drain

1. Ensure that the drain piping is downward (pitch of more than 20 mm/m) to the outdoor (discharge) side.
2. Ensure that any crosswise drain piping is less than 20 m (excluding the difference of elevation). If the drain piping is long, provide metal braces to prevent it from waving. Never provide any air vent pipe. Otherwise drain may be ejected.
3. Use a hard vinyl chloride pipe VP-25 (with an external diameter of 32 mm) for drain piping.
4. Ensure that collected pipes are 10 cm lower than the unit body's drain port.
5. Put the end of the drain piping in a position where no odor is generated.
6. Do not put the end of the drain piping in any drain where ionic gases are generated.

- ② Connect the inlet duct.
- ③ Drill a sensor hole (ø12.5 dia.) on the side on the duct.
- ④ Assemble the sensor and fixture.
- When pulling out the sensor, do not pull it by the lead wire. Doing so may result in wire breakage.
- Before connecting the inlet duct, make sure that the sensor, its fixture and protection plate are removed.
- The sensor removed in step ① must be re-installed in the position specified in the drawing. Installation of the sensor in an incorrect position may result in malfunction.
- Mount holes for outlet duct flange and inlet duct.

[Fig. 8.0.3] (P.4)

- Ⓐ Inlet duct flange
- Ⓑ PEH-RP8: 8 × 130pitch = 1040
PEH-RP10: 9 × 130pitch = 1170
- Ⓒ PEH-RP8: 24-ø3 holes (Inlet duct mount holes)
PEH-RP10: 26-ø3 holes (Inlet duct mount holes)
- Ⓓ Top of the unit
- Ⓔ Outlet duct flange
- Ⓕ PEH-RP8,10: 7 × 130pitch = 910
- Ⓖ PEH-RP8,10: 22-ø3 holes (Outlet duct mount holes)
- Ⓗ PEH-RP8,10: 2 × 130pitch = 260
- ① PEH-RP8,10: 2 × 100pitch = 200

- ③ Procure the following parts locally:
Switch box for two pieces
Thin copper conduit tube
Lock nuts and bushings

- (2) Seal the service entrance for the remote controller cord with putty to prevent possible invasion of dew drops, water, cockroaches or worms.

<A> For installation in the switch box:

- When the remote controller is installed in the switch box, seal the junction between the switch box and the conduit tube with putty.

 For direct installation on the wall select one of the following:

- Prepare a hole through the wall to pass the remote controller cord (in order to run the remote controller cord from the back), then seal the hole with putty.
- Run the remote controller cord through the cut-out upper case, then seal the cut-out notch with putty similarly as above.

B-1. To lead the remote controller cord from the back of the controller:

B-2. To run the remote controller cord through the upper portion:

[Fig. 9.1.1] (P.4)

- Ⓒ Wall
- Ⓓ Conduit
- Ⓔ Lock nut
- Ⓕ Bushing
- Ⓖ Switch box
- Ⓗ Remote controller cord
- ① Seal with putty

(3) Install the lower case in the switch box or on the wall.

[Fig. 9.1.1] (P.4)

<A> For installation in the switch box

- Ⓒ Switch box for two pieces Ⓓ Remote controller cord
- Ⓔ Cross-recessed, pan-head screw
- Ⓒ Seal the remote controller cord service entrance with putty

 For direct installation on the wall

- Ⓕ Wood screw

⚠ Caution:

Do not over-tighten the screws to possible deformed or broken lower case.

Note:

- Select a flat place for installation.
- Be sure to use two or more locations for securing of the remote controller in the switch box or on the wall.

9.2. Connecting procedures

- The remote controller cord may be extended up to 500 m. Since the remote controller cord supplied with the unit is 10 m-long, use those electric wires or (two-core) cables of 0.3 mm² to 1.25 mm² for extension. Do not use multi-conductor cables to prevent possible malfunction of the unit.

[Fig. 9.2.1] (P.4)

(1) Connect the remote controller cord to the terminal block for the lower case.

- Ⓐ To TB5 on the indoor unit
- Ⓑ Terminal block representation
No polarity

⚠ Caution:

Do not use crimp-style terminals for connection to the remote controller terminal block to eliminate contact with the boards and resultant trouble.

(2) Set the dip switch No.1 shown below when using two remote controller's for the same group.

[Fig. 9.2.2] (P.4) Dip switches

Setting the dip switches

The dip switches are at the bottom of the remote controller. Remote controller Main/Sub and other function settings are performed using these switches. Ordinarily, only change the Main/Sub setting of SW1. (The factory settings are all "ON".)

<SW No. 1>

SW contents Main	Remote controller Main/Sub setting
ON/OFF	Main/Sub
Comment	Set one of the two remote controllers at one group to "Main"

<SW No. 2>

SW contents Main	When remote controller power turned on
ON/OFF	Normally on/Timer mode on
Comment	When you want to return to the timer mode when the power is restored after a power failure when a Program timer is connected, select "Timer mode".

<SW No. 3>

SW contents Main	Cooling/heating display in AUTO mode
ON/OFF	Yes/No
Comment	When you do not want to display "Cooling" and "Heating" in the Auto mode, set to "No".

<SW No. 4>

SW contents Main	Intake temperature display
ON/OFF	Yes/No
Comment	When you do not want to display the intake temperature, set to "No".

9.3. Fitting the upper case

[Fig. 9.3.1] (P.4)

(1) Put the upper latches (at two locations) first then fit the upper case into the lower case as illustrated.

(2) To remove the upper case, put a slotted screwdriver tip in the latches as shown in the diagram then move the screwdriver in the direction of arrow.

⚠ Caution:

- Do not move the screwdriver while inserting the tip far into the latches to prevent broken latches.
- Be sure to put the screwdriver tip securely in the latches until a snap sounds. Loosely inserted screwdriver may fall down.

Note:

The operating section is covered with a protective sheet. Before using the unit, remember to remove the protective sheet.

9.4. Function settings

(1) Wired type

[Fig. 9.4.1] (P.4)

- ① Mode number
- Ⓓ Setting number
- Ⓖ Refrigerant address
- Ⓖ Unit number

Changing the power voltage setting

Be sure to change the power voltage setting when operating the unit in an area where the power source is 220 V or 230 V.

(The power voltage setting is set to 240 V at the factory. Units that are used in areas where the power source is 240 V do not require power voltage setting changes.)

[Operating instructions] (entering settings with a wired remote controller)

[Fig. 9.4.2] (P.5)

① Go to the function setting mode

Switch OFF the remote controller.

Press the Ⓐ FILTER and Ⓑ TEST RUN buttons simultaneously and hold them for at least 2 seconds. FUNCTION will start to flash. The refrigerant address display will start to flash momentarily.

② Setting the refrigerant address

Use the Ⓒ Ⓐ Ⓓ (TIMER SET) button to set the refrigerant address Ⓖ to 00. Press Ⓐ to increase the value or Ⓓ to decrease it.

00 is the typical setting. When operating in a group configuration, use the correlating refrigerant address (see the technical manual for details on setting the refrigerant address for a group). The refrigerant addresses must be set in order when performing the following operation.

* If the unit stops two seconds after the FUNCTION display starts to flash or [88] starts to flash in the room temperature display, a transmission problem may have occurred. Check to see if there is some source of transmission interference (noise) nearby.

If you make a mistake during any point of this procedure, you can quit the function setting mode by pressing Ⓒ once and then return to step ①.

③ Setting the unit number

Press Ⓓ (CLOCK ON OFF) and [-] will start to flash in the unit number Ⓖ display.

Use the Ⓒ Ⓐ Ⓓ (TIMER SET) button to set the unit number to 00. Press Ⓐ to increase the value or Ⓓ to decrease it.

Unit number 00 = the function setting selection for the entire refrigerant system

④ Setting the refrigerant address/unit number

Press the Ⓔ MODE button to designate the refrigerant address/unit number. [-] will flash in the mode number ① display momentarily.

* If [88] appears in the room temperature section, the selected refrigerant address does not exist in the system. Also, if [F] appears in the unit number display section, the selected unit number does not exist. Enter the correct refrigerant address and unit number at steps ② and ③.

Fan draft operation will start when settings are confirmed using the Ⓔ MODE button. You can also use this operation to find out what functions are assigned to which unit numbers and the locations of those indoor units. Note that the fan draft operation will start for all of the indoor units that have been assigned refrigerant addresses when 00 or AL is the assigned unit number.

* If an indoor unit other than those designated with refrigerant addresses emits a fan draft when a different refrigerant grouping is being used, the set refrigerant addresses have probably overlapped. Reassign the refrigerant addresses at the DIP switch of the outdoor unit.

Example) When the refrigerant address is set to 00 and the unit number is 02.

[Fig. 9.4.3] (P.5)

- (a) Outdoor unit
- (b) Indoor unit
- (c) Designate operation
- (d) Remote controller

⑤ Selecting the mode number

Press the Ⓔ Ⓐ Ⓓ (TEMP) buttons to set the mode number ① to 04. Press Ⓐ to increase the value or Ⓓ to decrease it.

① Mode number 04 = power voltage switching mode

⑥ Selecting the setting number

"1" will start to flash as the currently specified setting number Ⓓ when the Ⓒ button Ⓒ is pressed. Use the Ⓐ Ⓓ (TEMP) buttons to specify "2" as the setting number. Press Ⓐ to increase the value or Ⓓ to decrease it.

Ⓓ Setting number 1 = 240 V

Ⓓ Setting number 2 = 220 V/230 V

⑦ Designating the mode and setting numbers

The mode and setting numbers ① Ⓓ will start to flash when the MODE button Ⓔ is pressed and the designation operation will begin. The numbers are set when the flashing settings stay lit.

* If [-] appears in the room temperature display as the mode/setting number, or if a flashing [88] display appears, a transmission problem may have occurred. Check to see if there is some source of transmission interference (noise) nearby.

⑧ **Complete function selection**

Press the FILTER Ⓐ and TEST RUN Ⓑ buttons simultaneously for at least two seconds. The function selection screen will disappear momentarily and the air conditioner OFF display will appear.

* Do not use the remote controller for 30 seconds after completing the function selection.

Other function selections

Now that you know how to change the power voltage setting, there are several other settings that can be changed as well. The following Table lists the various settings that can be changed through the remote controller and the default settings of the various units.

Table 1. Initial setting

Mode no.	Settings no.	Outdoor unit	
		PUHZ	PUH
01	1	○	○
	2		
02	1	○	○
	2		
	3		
03	1	○	○
	2		
	3		
04	1		○
	2	○	
05	1	○	-
	2		

Mode no.	Settings no.	Indoor unit	
		PEH-RP-MYA	
07	1		
	2		
	3		○
08	1		
	2		-
	3		
09	1		
	2		-
	3		
10	1		-
	2		
11	1		
	2		-
	3		
12	1		-
	2		

Things to remember when entering function selections:

The basic procedure for entering function selections is the same as described for switching between power voltages. However, there are some differences at step ③ for selecting the unit number, step ⑤ for selecting the mode number and step ⑥ for selecting the unit number. The following Tables 2 and 3 list the various function settings, mode numbers and setting numbers. Table 2 details the functions of the entire refrigerant system while Table 3 shows the functions that can be set for the indoor unit.

Table 2. Function table

Select unit number 00

Mode	Settings	Mode no.	Setting no.	Setting
Power failure automatic recovery	Not available	01	1	
	Available		2	
Indoor temperature detecting	Indoor unit operating average	02	1	
	Set by indoor unit's remote controller		2	
	Remote controller's internal sensor		3	
LOSSNAY connectivity	Not Supported	03	1	
	Supported (indoor unit is not equipped with outdoor-air intake)		2	
	Supported (indoor unit is equipped with outdoor-air intake)		3	
Power voltage	240 V	04	1	
	220 V, 230 V		2	
Auto mode	Energy saving cycle automatically enabled	05	1	
	Energy saving cycle automatically disabled		2	

Table 3. Function table

Select unit numbers 01 to 03 or all units (AL [wired remote controller]/107 [wireless remote controller])

Mode	Settings	Mode no.	Setting no.	Setting
Filter sign	100Hr	07	1	
	2500Hr		2	
	No filter sign indicator		3	
Fan speed	Quiet	08	1	
	Standard		2	
	High ceiling		3	
No. of air outlets	4 directions	09	1	
	3 directions		2	
	2 directions		3	
Installed options (high-performance filter)	Not supported	10	1	
	Supported		2	
Up/down vane setting	No vanes	11	1	
	Equipped with vanes (vaner angle setup ①)		2	
	Equipped with vanes (vaner angle setup ②)		3	
Energy saving air flow (Heating mode)	Disabled	12	1	
	Enabled		2	

③ Setting the unit numbers

Set "00" as the unit number when setting functions from Table 2.

When setting functions from Table 3:

- When setting functions for an indoor unit in an independent system, set the unit number to 01.
- When setting functions for a simultaneous-Twin Triple indoor unit system, assign unit numbers from 01 to 03 to each indoor unit.
- When setting the same functions for an entire simultaneous Twin Triple-indoor unit system, assign "AL" as the unit number.

⑤ Selecting the mode number

Select from Table 2 and Table 3.

⑥ Selecting the setting number

Select from Table 2 and Table 3.

(2) Wireless remote controller type

[Fig. 9.4.4] (P.5)

Changing the power voltage setting

Be sure to change the power voltage setting depending on the voltage used.

① Go to the function select mode

Press the **CHECK** button **F** twice continuously.

(Start this operation from the status of remote controller display turned off.)

CHECK is lighted and "00" blinks.

Press the temp **▼** button **C** once to set "50". Direct the wireless remote controller toward the receiver of the indoor unit and press the **h** button **A**.

② Setting the unit number

Press the temp **▼** **▲** button **C** and **D** to set the unit number "00". Direct the wireless remote controller toward the receiver of the indoor unit and press the **min** button **B**.

③ Selecting a mode

Enter 04 to change the power voltage setting using the **▼** **C** and **▲** **D** buttons. Direct the wireless remote controller toward the receiver of the indoor unit and press the **h** button **A**.

Current setting number: 1 = 1 beep (one second)
 2 = 2 beeps (one second each)
 3 = 3 beeps (one second each)

④ Selecting the setting number

Use the **▼** **C** and **▲** **D** buttons to change the power voltage setting to 01 (240 V). Direct the wireless remote controller toward the sensor of the indoor unit and press the **h** button **A**.

⑤ To select multiple functions continuously

Repeat steps ③ and ④ to change multiple function settings continuously.

⑥ Complete function selection

Direct the wireless remote controller toward the sensor of the indoor unit and press the **▶** button **E**.

Note:

Whenever changes are made to the function settings after construction or maintenance, be sure to record the added functions with an "○", in the "Check" column provided on the chart.

10. Electrical wiring

Precautions on electrical wiring

⚠ Warning:

Electrical work should be done by qualified electrical engineers in accordance with "Engineering Standards For Electrical Installation" and supplied installation manuals. Special circuits should also be used. If the power circuit lacks capacity or has an installation failure, it may cause a risk of electric shock or fire.

- Be sure to take power from the special branch circuit.
- Be sure to install an earth leakage breaker to the power.
- Install the unit to prevent that any of the control circuit cables (remote controller, transmission cables) is brought in direct contact with the power cable outside the unit.
- Ensure that there is no slack on all wire connections.
- Some cables (power, remote controller, transmission cables) above the ceiling may be bitten by mice. Use as many metal pipes as possible to insert the cables into them for protection.
- Never connect the power cable to leads for the transmission cables. Otherwise the cables would be broken.
- Be sure to connect control cables to the indoor unit, remote controller, and the outdoor unit.
- Put the unit to the ground on the outdoor unit side.
- Be sure to connect between the control cable terminal block of the outdoor unit and that of the indoor unit. (Cables have polarity, so make sure that they are connected according to the terminal numbers.)
- Fix power source wiring to control box by using buffer bushing for tensile force (PG connection or the like). Connect control wiring to control terminal bed through the knockout hole of control box using ordinary bushing.

In case of A-control wiring there is high voltage potential on the S3 terminal caused by electrical circuit design that has no electrical insulation between power line and communication signal line. Therefore, please turn off the main power supply when servicing. And do not touch the S1, S2, S3 terminals when the power is energized. If isolator should be used between indoor unit and outdoor unit, please use 3-potes type.

⚠ Caution:

Be sure to put the unit to the ground on the outdoor unit side. Do not connect the earth cable to any gas pipe, water pipe, lightning rod, or telephone earth cable. Incomplete grounding may cause a risk of electric shock.

[Fig. 10.0.1] (P.6)

- Ⓐ Power supply
- Ⓑ Main switch/fuse (purchased locally)
- Ⓒ Power supply wiring for outdoor unit
- Ⓓ Power supply wiring for indoor unit
- Ⓔ Outdoor unit
- Ⓕ Indoor unit
- Ⓖ Connection wiring for indoor/outdoor units (polarity)
- Ⓗ Remote controller
- Ⓘ Connection wiring for indoor/remote controller (no polarity)
- Ⓚ Grounding
- Ⓛ Signal wiring for alternate defrost

[Fig. 10.0.2] (P.6)

- Ⓐ Indoor unit
- Ⓑ Power cable wiring
- Ⓒ Control cable wiring
- Ⓓ Outdoor unit
- Ⓔ Breaker
- Ⓕ Fuse
- Ⓖ Power cable terminal bed
- Ⓗ Control cable terminal bed
- Ⓘ Defrost signal cable terminal bed
- Ⓚ Defrost signal cable wiring

⚠ Caution:

Make sure that refrigerant pipe and wiring unit must be connect from Outdoor unit No.1 to Indoor unit No.1 and Outdoor unit No.2 to Indoor unit No.2 respectively.

Wiring from Outdoor unit No.1 must be connect to terminal bed TB4-1 in control box of Indoor unit No.1 while wiring from Outdoor unit No.2 must be connect to terminal bed TB4-2 in control box of Indoor unit No.2.

Any mistakes on those connections may cause an abnormal refrigerant pipe temperature and etc.

[Wiring example] (For metal piping)

	Power Cable	Breaker Capacity	Fuse	Control Cable
PEH-RP8MYA	1.5 mm ² or thicker	15 A	15 A	Cable or wire of 0.8 mm ² or Thicker (12 VDC)
PEH-RP10MYA	1.5 mm ² or thicker	15 A	15 A	

* The grounding wire must be of the same diameter as the power cable wires.

[Selecting earth leakage breaker (NV)]

To select NF or NV instead of a combination of Class B fuse with switch, use the following:

- In the case of Class B fuse rated 15 A

Fuse (class B)	15 A
Earth leakage breaker ELB (with over-load protection)	NV-30CA 15 A 30 mA 0.1s or less

NV is a product name of MITSUBISHI.

- Power supply cords of appliances shall not be lighter than design 245 IEC53 or 227 IEC53.
- A switch with at least 3 mm contact separation in each pole shall be provided by the Air conditioner installation.
- The connection wiring between the outdoor and indoor units can be extended up to a maximum of 50 m, and the total extension including the crossover wiring between rooms is a maximum of 80 m.

⚠ Caution:

Do not use anything other than the correct capacity breaker and fuse. Using fuse, wire or copper wire with too large capacity may cause a risk of malfunction or fire.

Location of cable holes

[Fig. 10.0.3] (P.6)

- Ⓐ For remote controller cables
- Ⓑ For outdoor unit connection cables
- Ⓒ For power supply cables

- Switching the external static pressure (PEH-RP8, 10MYA ONLY)
The unit has been set at the factory so that the standard amount of air is provided when the static pressure outside the unit is 50 Pa. However, it is possible to change the motor torque so that the standard amount of air is provided when the static pressure outside the unit is 150 Pa. This can be done by removing the white connector and connecting the red one (both connectors are provided inside the control box) as shown below.

[Fig. 10.0.4] (P.6)

- Ⓐ White connector (50 Pa) C01
- Ⓑ Red connector (150 Pa) C02
- Ⓒ Remove

11. Test run

11.1. Before test run

The test run can be carried out either from the outdoor unit or the indoor unit.

1. Checklist

- After the installation, piping setup, and wiring of the indoor and outdoor units is complete, check that refrigerant is not leaking, the power and control wires are not loose, and the poles are not reversed.
- Use a 500 V insulation resistance tester to make sure that the resistance between the power terminal and the ground is 1.0 MΩ or more. If it is less than 1.0 MΩ, do not operate the unit. * Absolutely do not touch the tester to indoor/outdoor connection terminals S1, S2, and S3. An accident could occur.
- Make sure there is no malfunction in the outdoor unit. (If there is a malfunction, you can diagnose it using LED2 on the board.)
- Check that the ball valve is fully open on both the liquid and gas ends.
- Check the electrical power phase. If the phase is reversed, the fan may rotate in the wrong direction or stop, or unusual sounds may be produced.
- Starting at least 12 hours before the test run, send current through the crankcase heater. (If the current is running for a shorter period of time, damage to the compressor could result.)
- For specific models requiring changing of settings for higher ceilings or selection of power supply ON/OFF capability, make proper changes referring to the description for Selection of Functions through Remote Controller.

After the above checks are complete, carry out the test run as indicated in the following outline.

11.2. Test run procedures

1) Indoor unit

[Fig. 11.2.1] (P.6)

Operating procedures

① Turn on the main power supply

While the room temperature display on the remote controller reads "CENTRALLY CONTROLLED", the remote controller is disabled. Turn off the "CENTRALLY CONTROLLED" display before using the remote controller.

② Press "TEST RUN" button twice

- Ⓐ The 'TEST RUN' indicator should light up.

③ Press button

Cooling/drying mode: Cool air should start to blow.

Heating mode: Warm air should start to blow (after a while).

④ Press button

Check for correct motion of auto-vanes.



⑤ Check the outdoor unit fan for correct running

The outdoor unit features automatic capacity control to provide optimum fan speeds. The fan keeps running at a low speed to meet the current outside air condition unless it exceeds its available maximum power. Then, in actuality, the fan may stop or run in the reverse direction depending on the outside air, which does not mean malfunction.

⑥ Press the "ON/OFF" button to reset the test run in progress

- The test run will be automatically shut down after two hours in response to the AUTO STOP setting of two hours on the timer.
- During the test run, the room temperature display shows the indoor unit tubing temperatures.
- In the case of the test run, the OFF timer will activate, and the test run will automatically stop after two hours.
- The room temperature display section shows the control temperature for the indoor units during the test run.
- Check that all the indoor units are running properly for simultaneous twin and triple operation.
Malfunctions may not be displayed even if the wiring is incorrect.

(*1)

After turning ON the power, the system will go into startup mode, and the remote controller operation lamp (red) and the room temperature display section's "H0" will flash. Also, in the case of the indoor substrate LEDs, LED 1 and LED 2 light up (when address is 0) or become dim (when address is not 0), and LED 3 flashes. In the case of the outdoor substrate LED display,  and  are displayed alternately at 1-second intervals.

- If one of the above operations does not function correctly, the following causes should be considered, and if applicable, dealt with. (The following symptoms have been determined under test run mode. Note that "startup" in the chart means the *1 display above.)

Symptoms		Cause
Remote Controller Display	Outdoor Substrate LED Display	
Remote controller is displaying "H0", and operation is not possible.	After "startup" display, "00" is displayed (correct operation).	• After power is turned ON, system startup lasts for about 2 mins., and "H0" is displayed (correct operation).
After power is turned ON, "H0" is displayed for 3 mins., then error code is displayed.	After "startup" display, error code is displayed.	• Outdoor unit's safeguard installation connector is open.
	After "startup" display, "F1" (negative phase) is displayed.	• Negative phase and open phase of outdoor unit's power terminal board (Single phase: L, N, ⊕/triple phase: L1, L2, L3, N, ⊕)
Power is turned ON, and "EE" or "EF" are displayed after "H0" is displayed.	After "startup" display, "F1" (negative phase) is displayed.	• Incorrect connection of outdoor terminal board (Single phase: L, N, ⊕/triple phase: L1, L2, L3, N, ⊕ grounding and S1, S2, S3)
	After "startup" display, "00" or "EE" is displayed ("EE" is displayed when a test run is made).	• Outdoor unit and indoor unit construction differ
Display messages do not appear even when remote controller operation switch is turned ON (operation lamp does not light up).	After "startup" display, "EA" (error for number of units) or "Eb" (unit number error) is displayed.	• Wiring for the indoor and outdoor unit is not connected correctly. (Polarity is wrong for S1, S2, S3)
	After "startup" display, "00" is displayed (correct operation).	• Remote controller transmission wire short
	After "startup" display, "00" is displayed (correct operation).	• There is no outdoor unit for address 0 (address is something other than 0).
Operation display appears but soon disappears even when remote controller operations are executed.	After "startup" display, "00" is displayed (correct operation).	• Remote controller transmission wire burnout
	After "startup" display, "00" is displayed (correct operation).	• After cancellation of function selection, operation is not possible for about 30 secs. (correct operation).

* Press the remote controller's "CHECK" button twice consecutively to be able to run a self diagnosis. See the chart below for content of error code displays.

LCD	Nonconformity Content	LCD	Nonconformity Content	LCD	Nonconformity Content
P1	Suction sensor error	P8	Tube temperature error	E6 ~ EF	Signal error between indoor and outdoor units
P2	Tubing (liquid) sensor error	P9	Tube (2-phase tube) sensor error	- - - -	No error history
P4	Drain sensor error	U0 ~ UP	Outdoor unit nonconformity	FFFF	No relevant unit
P5	Drain overflow safeguard operation	F1 ~ FA	Outdoor unit nonconformity		
P6	Freezing/overheating safeguard operation	E0 ~ E5	Signal error between remote controller and indoor unit		

See the chart below for details of the LED displays (LED 1, 2, 3) on the indoor substrate.

LED 1 (microcomputer power supply)	Displays the ON/OFF of power for control. Check that this is lit during normal use.
LED 2 (remote controller feed)	Displays the ON/OFF of feed to wired remote controller. Is only lit for indoor unit linked to outdoor unit with address "00".
LED 3 (indoor and outdoor signals)	Displays signal between indoor and outdoor units. Check that this is flashing during normal use.

2) Outdoor unit

1) Check Items

- After installation of indoor and outdoor units, and tubing and electric wiring work, check that the unit is free from leaks of refrigerant, loosened connections, and incorrect polarity.
- Check that there is no negative phase and open phase. (The F1 message for negative phase and the F2 message for open phase will flash at LED 1 on the outdoor substrate. If this happens, rewire correctly.)
- Measure the impedance between power terminals (Single phase: L, N, ⊕ / triple phase: L1, L2, L3, N, ⊕) and the ground with a 500 V Megger and check that it is 1.0 MΩ or more. Do not operate the equipment if measurement is less than 1.0 MΩ. * Never conduct this operation on the outdoor connection wiring terminals (S1, S2, S3) as this causes damage.
- When there is no error at the outdoor unit.
(If there is an error at the outdoor unit, it can be evaluated at LED 1 [digital display] of the outdoor substrate.)
- The stop valves are open both the liquid and gas sides.
After checking the above, execute the test run in accordance with the following.

2) Test run start and finish

- Operation from the indoor unit
Execute the test run using the installation manual for the indoor unit.
- Operation from the outdoor unit
Execute settings for test run start, finish and operation mode (cooling, heating) using the DIP switch SW 4 on the outdoor substrate.

[Fig. 11.2.2] (P.6)

- | | |
|-------------|-----------|
| Ⓐ Stop | Ⓑ Cooling |
| Ⓒ Operation | Ⓓ Heating |

- Set the operation mode (cooling, heating) using SW 4-2
 - Turn ON SW 4-1, The operation mode for SW 4-2 will be adhered to, and the test run will commence
 - Turn OFF SW 4-1 to finish the test run
- There may be a faint knocking noise emitted from the proximity of the fan during the test run. This is torque fluctuation occurring due to control of fan revolutions. There is no problem with the product.

Note:

The SW 4-2 operation mode cannot be changed during the test run. (To change test run mode, stop the equipment with SW 4-1, change the operation mode, then restart test run with SW 4-1.)

- If the 2-hour timer is set, the test run will stop automatically after 2 hours.
- During the test run, the room temperature display on the indoor unit will indicate the temperature of the indoor unit piping.

11.3. Self-diagnosis

Use the remote controller to look up each units error history.

[Fig. 11.3.1] (P.7)

- Change to self-diagnosis mode
Press the CHECK button twice within three seconds to show the following display.
- Select the refrigerant address number to be self-diagnosed
Press the buttons to scroll through the refrigerant address numbers (00 to 15) and select the refrigerant address number to be self-diagnosed. After three seconds from making the change, the lit refrigerant address to be self-diagnosed will start to flash, and self-diagnosis will commence.
- Self-diagnosis result display
See the above chart for details of error code contents.
 - When there is an error history
 - When there is no error history
 - When the address does not exist

- | | |
|------------------------------|----------------|
| a) Alternating display | b) Error code |
| c) Attribute of error search | d) Unit number |

④ Reset error history

Display the error history at the self-diagnosis result display screen ③.

The address for self-diagnosis will flash when the button is pressed twice within three seconds.

The diagram on the left will be displayed when error history has been reset. Note that the error content will be redisplayed if error history resetting is unsuccessful.

- | |
|------------------------|
| a) Alternating display |
|------------------------|

⑤ Canceling self-diagnosis

The following two methods can be used to cancel self-diagnosis.

Press the CHECK button twice within three seconds to cancel self-diagnosis. The display screen will return to the status before self-diagnosis.

Press the ON/OFF button to cancel self-diagnosis. The indoor unit will stop. (This operation is ineffectual when operation is prohibited.)

11.4. Remote controller diagnosis

If operation cannot be carried out from the remote controller, use this function to diagnose the remote controller.

[Fig. 11.4.1] (P.7)

① First, check the electricity current marker

If the correct voltage (DC 12 V) is not displayed on the remote controller, the electric current marker will be lit.

If the electricity current marker is not lit, check the remote controller wiring and the indoor units.

- | |
|---------------------------|
| ① Electric current marker |
|---------------------------|

② Transfer to remote control mode

Hold down the CHECK button for five seconds or more to display the diagram on the left.

Press the FILTER button to commence diagnosis of remote controller.

③ Remote controller diagnosis results

- The remote control is functioning correctly.
Check other possible causes as there are no problems with the remote controller.
- The remote controller has a nonconformity.
The remote controller must be replaced.
Error display 1 ("NG") flashes to show a nonconformity in the transmitter-receiver circuit.

Potential problems other than those diagnosed for the remote controller.

- Single transmission not possible if error display 2 ("E3") flashes.
There is "noise" on the transmission line, or damage of other remote controllers for the indoor units can be considered. Check the transmission path and other controllers.
- Data error has occurred when error display three shows "ERC" and number of data errors.
Number of generated data errors (maximum 66 errors).
The number of generated data errors stands for the difference in the number of bits of transmitted data from the remote controller and the actual number of bits that were transmitted along the transmission path. If this error occurs, "noise", etc., is interfering with the transmission data. Check the transmission path.

Ⓚ When the number of data errors generated is 02
Ⓛ Remote controller transmission data
Ⓜ Transmission data at transmission path
- Cancel the remote controller diagnosis
Hold down the CHECK button for five seconds or more to cancel the remote controller diagnosis. The "H0" operation lamp will flash, and the display screen will return to the status before remote controller diagnosis in approximately 30 seconds.

12. Test run [for wireless remote controller]

12.1. Before test run

- ▶ After completing installation and the wiring and piping of the indoor and outdoor units, check for refrigerant leakage, looseness in the power supply or control wiring, and wrong polarity.
- ▶ Use a 500-volt megohmmeter to check that the resistance between the power supply terminals and ground is at least 1.0 MΩ.
- ▶ Do not carry out this test on the control wiring (low voltage circuit) terminals.

Warning:
Do not use the air conditioner if the insulation resistance is less than 1.0 MΩ.

Caution:
The compressor will not operate unless the power supply phase connection is correct.

• For description of each check code, refer to the following table.

① Check code	Symptom	② Buzzer sound	③ OPE LED
P1	Intake sensor error	Single beep × 1	Lit for 1 sec. × 1
P2	Pipe sensor error	Single beep × 2	Lit for 1 sec. × 2
P4	Drain sensor error	Single beep × 4	Lit for 1 sec. × 4
P5	Drain pump error	Single beep × 5	Lit for 1 sec. × 5
P6	Freezing / Overheating safeguard operation	Single beep × 6	Lit for 1 sec. × 6
P8	Pipe temperature error	Single beep × 8	Lit for 1 sec. × 8
P9	TH5 sensor error	Single beep × 2	Lit for 1 sec. × 2
U0-UP	Outdoor unit error	Double beep × 1	Lit for 0.4 sec. + 0.4 sec. × 1
F1-FA	Outdoor unit error	Double beep × 1	Lit for 0.4 sec. + 0.4 sec. × 1
E0-E5	Signal error between remote controller and indoor units	Sounds other than above	Lights other than above
E6-EF	Communication error between indoor and outdoor units	Sounds other than above	Lights other than above
--	No alarm history	No sound	Not lit
F F F F	No unit	Triple beep	Not lit

- On wireless remote controller
- ② The continuous buzzer sounds from receiving section of indoor unit.
- ③ Blink of operation lamp
- On wired remote controller
- ① Check code displayed in the LCD.

• If the unit cannot be operated properly after the above test run has been performed, refer to the following table to remove the cause.

Symptom		Cause
Wired remote controller	LED 1, 2 (PCB in outdoor unit)	
H0	For about 2 minutes following power-on	After LED 1, 2 are lighted, LED 2 is turned off, then only LED 1 is lighted. (Correct operation)
H0 → Error code	After about 2 minutes has expired following power-on	Only LED 1 is lighted. → LED 1, 2 blink.
Display messages do not appear even when operation switch is turned ON (operation lamp does not light up).		Only LED 1 is lighted. → LED 1 blinks twice, LED 2 blinks once.

On the wireless remote controller with condition above, following phenomena takes place.

- No signals from the remote controller are accepted.
- OPE lamp is blinking.
- The buzzer makes a short pipng sound.



Note:
Operation is not possible for about 30 seconds after cancellation of function selection. (Correct operation)

For description of each LED (LED1, 2, 3) provided on the indoor controller, refer to the following table.

LED1 (power for microcomputer)	Indicates whether control power is supplied. Make sure that this LED is always lit.
LED2 (power for remote controller)	Indicates whether power is supplied to the remote controller. This LED lights only in the case of the indoor unit which is connected to the outdoor unit refrigerant address "0".
LED3 (communication between indoor and outdoor units)	Indicates state of communication between the indoor and outdoor units. Make sure that this LED is always blinking.













12.2. Self-check



[Fig. 12.2.1] (P.8)

- ① Turn on the power.
- ② Press the  button twice. (Start this operation from the status of remote controller display turned off.)
 - Ⓐ  begins to light.
 - Ⓑ «00» begins to blink.
- ③ While pointing the remote controller toward the unit's receiver, press the  button. The check code will be indicated by the number of times that the buzzer sounds from the receiver section and the number of blinks of the operation lamp.
- ④ Press the ON/OFF button to stop the self-check.

12.3. Test run method

[Fig. 12.3.1] (P.8)

- ① Turn on the power to the unit at least 12 hours before the test run.
- ② Press the  button twice continuously.
(Start this operation from the status of remote controller display turned off.)
Ⓐ  and current operation mode are displayed.
- ③ Press the  (   ) button to activate **COOL** mode, then check whether cool air is blown out from the unit.
- ④ Press the  (   ) button to activate **HEAT** mode, then check whether warm air is blown out from the unit.

- ⑤ Press the  button and check whether fan speed changes.
- ⑥ Press the  button and check whether the auto vane operates properly.
- ⑦ Press the **ON/OFF** button to stop the test run.

Note:

- Point the remote controller towards the indoor unit receiver while following steps ② to ⑦.
- It is not possible to run in FAN, DRY or AUTO mode.

13. Troubleshooting

13.1. How to handle problems with the test run

Error code list: details

Error details	Problem location	MELANS display	Remote controller display
Remote controller communication – reception error	Remote Controller	6831,6834	E0
Remote controller communication – transmission error	Remote Controller	6832,6833	E3
Remote controller communication – reception error	Indoor unit	6831,6834	E4
Remote controller communication – transmission error	Indoor unit	6832,6833	E5
Communication between indoor and outdoor units – reception error	Indoor unit	6740,6843	E6
Communication between indoor and outdoor units – transmission error	Indoor unit	6841,6842	E7
Communication between indoor and outdoor units – reception error	Outdoor unit	6840,6843	E8
Communication between indoor and outdoor units – transmission error	Outdoor unit	6841,6842	E9
Indoor/outdoor connection wiring error, indoor unit overload (5 units or more)	Outdoor unit	6844	EA
Indoor/outdoor connection wiring error (interference, loose)	Outdoor unit	6845	EB
Excessive time in use	Outdoor unit	6846	EC
Serial communication error	Outdoor unit	0403	ED
Serial communication error	M-NET board	0403	EE
Reverse phase, out of phase verification	Outdoor unit	4103	F1
Faulty input circuit	Outdoor unit	4115	F8
Duplicated M-NET address setting	M-NET board	6600	A0
M-NET error in PH/W transmission	M-NET board	6602	A2
M-NET bus busy	M-NET board	6603	A3
M-NET communication error with P transmission	M-NET board	6606	A6
M-NET error – no ACK	M-NET board	6607	A7
M-NET error- no response	M-NET board	6608	A8
Undefined error code	–	undefined	EF
Outlet temperature error	Outdoor unit	1102	U2
CN23 Short-circuit Connector Unplugged	Outdoor unit	1108	U2
Open/short in discharge temp thermistor	Outdoor unit	5104	U3
Open/short in liquid temp or condenser/evaporater temp thermistor	Outdoor unit	5105	U4
Compressor overcurrent interruption (51C operation)	Outdoor unit	4101	U6
High pressure error (63H1 operation)	Outdoor unit	1302	UE
Low pressure error (63L operation)	Outdoor unit	1300	UL
Power synchronous idle circuit error	Outdoor unit	4115	F8
Inlet sensor error	Indoor unit	5101	P1
Piping sensor error	Indoor unit	5102	P2
Drain sensor error	Indoor unit	2503	P4
Drain overflow protector operation	Indoor unit	2502	P5
Water leak error (PDH only)	Indoor unit	2500	P5
Freeze prevention operation	Indoor unit	1503	P6
Surge prevention operation	Indoor unit	1504	P6
Piping temperature error	Indoor unit	1110	P8

- Depending on the position of the SW2 switch on A Control Service Tool, the segments light up to indicate the running condition of the unit and the particulars of the check code.

SW2 setting 123456	Item	Display contents	
000000	Operation mode/relay output	tens place units place	O: stop C: cooling H: heating d: defrosting 1: SV 2: 21S4 4: MC 8: Warning-up MC When an error occurs, the error code and error signal (*1) are displayed in alternation.
011100	Error code history 1	Relay output = SV + 21S4 + MC Ex. During cooling mode, when MC and SV are ON: C5	
111100	Error code history 2		
		The error code (ex. U8, UA) and error indicator (*1) are displayed in alternation.	

*1 Display system for error indicator

The indicator corresponds to the following numbers

- 0 Outdoor unit
- 1 Indoor unit No.1
- 2 Indoor unit No.2
- 3 Indoor unit No.3
- 4 Indoor unit No.4

13.2. The following occurrences are not problems or errors

Problem	Remote controller display	Cause
The fan setting changes during heating.	Ordinary display	During thermostat OFF mode, light air or low air operation will take place. During thermostat ON mode, light air or low air will switch automatically to set notch on the basis of time or piping temperature.
The fan stops during heating.	Defrosting display	During defrosting, the fan will stop.
When the switch is turned ON, the fan does not begin to operate.	Heating preparations underway	After the switch is turned to ON or until the piping temperature reaches 35°C, there will be 5 minutes of light air operation. After that there will be 2 minutes of low air operation, then set notch will begin (hot adjustment control).
The outdoor unit fan turns in reverse or stops, and an unusual sound is heard.	Ordinary display	There is a risk of the power to the outdoor unit being connected in reverse phase. Be sure to check that the phase is correct.

Note:

If the fan in the indoor unit does not operate, check the over-current relay on the fan motor to determine whether it has been tripped.

If the over-current relay has been tripped, reset it after eliminating the cause of the problem (e.g. motor lock).

To reset the over-current relay, open the control box and press the green claw on bottom-right of the relay until a click is heard. Release the claw and check that it returns to its original position.

Note that if it is pressed too hard it will not return to its original position.

14. System control

14.1. System settings

[Fig. 14.1.1] (P.8)

- Ⓐ Outdoor unit
- Ⓑ Indoor unit
- Ⓒ Master remote controller
- Ⓓ Subordinate remote controller
- Ⓔ Standard 1:1 (Refrigerant address = 00)

* Set the refrigerant address using the DIP switch of the outdoor unit.

① Wiring from the Remote Control

This wire is connected to TB5 (terminal board for remote controller) of the indoor unit (non-polar).

② When a Different Refrigerant System Grouping is Used

Up to 16 refrigerant systems can be controlled as one group using the slim MA remote controller.

Note:

In single refrigerant system, there is no need of wiring ②.

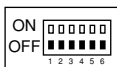
SW1 Function table	Function	Operation according to switch setting	
		ON	OFF
<SW1> 	1 Compulsory defrosting	Start	Normal
	2 Error history clear	Clear	Normal
	3 Refrigerant system address setting	Settings for outdoor unit addresses 0 to 15	
	4		
	5		
	6		

14.2. Examples of refrigerant system address setting

Ex.	Indoor unit	Outdoor unit	Outdoor unit refrigerant system address	Remote controller power supply unit
1	PEH-RP8-10MYA	-	00	○

* Set the refrigerant system address of one outdoor unit to 00 for the power supply to the remote controller.

(The refrigerant system address is set to 00 when shipped from the factory.)

Do not duplicate the refrigerant system address settings within the same system.

This product is designed and intended for use in the residential, commercial and light-industrial environment.

The product at hand is based on the following EU regulations:

- Low Voltage Directive 73/23/EEC
- Electromagnetic Compatibility Directive 89/336/EEC

Please be sure to put the contact address/telephone number on this manual before handing it to the customer.